



.223 & .308 RIFLE DATA BOOK

LAW ENFORCEMENT

ATK TAKES THE LEAD IN PROVEN PERFORMANCE. Since its inception, the FBI Testing Protocol for handgun ammunition has become the standard by which many Law Enforcement Agencies across the nation evaluate service pistol ammunition performance. In publishing the original Rifle Data Book, ATK proved to be industry leaders in testing Law Enforcement rifle ammunition utilizing the same recognizable testing standard used for pistols. This new Rifle Data Book follows that lead — testing new Law Enforcement Rifle Ammunition from Federal Premium® and Speer®.

This data book provides invaluable data with initial performance assessments of our law enforcement rifle ammunition. It features new additions to the ATK lineup like Speer® Gold Dot® rifle, Federal Premium® Lite Open Tip Match and a new TRU® loading with Barnes® Triple-Shock® X-Bullet™. This will allow officers to tailor loads to be mission specific or choose a round for overall effectiveness.















To review existing data, our original Rifle Data Book is available in the catalog section of our website at www.le.atk.com and contains all of our initial law enforcement offerings.

















.223

HEAVY CLOTHING

BARE GELATIN

| Caliber | Wound Characteristics | Stats | Recovered Bullet |
|--|---|---|---|
| T223S Tactical® TRU® 223-55 Gr. Barnes® Triple-Shock® X-Bullet™ |  | Velocity 2764 Penetration 18.5" Expansion .508" Retained Wt. 55 Gr. Percent Wt. Retained 100% |  |
| 24455 Gold Dot® 5.56x45mm-55 Gr. Bonded Soft Point |  | Velocity 3013 Penetration 14" Expansion .488" Retained Wt. 43.6 Gr. Percent Wt. Retained 79.27% |  |
| 24448 Gold Dot® 223-64 Gr. Bonded Soft Point |  | Velocity 2692 Penetration 19" Expansion .347" Retained Wt. 36 Gr. Percent Wt. Retained 56.25% |  |
| T556L0TM1 Tactical® 5.56x45mm-43 Gr. Lite Open Tip Match |  | Velocity 3212 Penetration 7" Expansion Fragment Retained Wt. NA Percent Wt. Retained NA |  |
| T556L0TM2 Tactical® 5.56x45mm-50 Gr. Lite Open Tip Match |  | Velocity 3219 Penetration 7" Expansion Fragment Retained Wt. NA Percent Wt. Retained NA |  |
| T223M Tactical® TRU® 223-69 Gr. Sierra® MatchKing® BTHP |  | Velocity 2613 Penetration 13" Expansion .406 Retained Wt. 33 Gr. Percent Wt. Retained 46.83% |  |
| T223M3 Tactical® TRU® 223-77 Gr. Sierra® MatchKing® BTHP |  | Velocity 2437 Penetration 16" Expansion .351" Retained Wt. 11.3 Gr. Percent Wt. Retained 14.68% |  |

| Caliber | Wound Characteristics | Stats | Recovered Bullet |
|--|---|--|---|
| T223S Tactical® TRU® 223-55 Gr. Barnes® Triple-Shock® X-Bullet™ |  | Velocity 2764 Penetration 16.5" Expansion .513" Retained Wt. 52.2 Gr. Percent Wt. Retained 94.91% |  |
| 24455 Gold Dot® 5.56x45mm-55 Gr. Bonded Soft Point |  | Velocity 3013 Penetration 14.75" Expansion .5910" Retained Wt. 55 Gr. Percent Wt. Retained 100% |  |
| 24448 Gold Dot® 223-64 Gr. Bonded Soft Point |  | Velocity 2692 Penetration 14.75" Expansion .6905" Retained Wt. 64 Gr. Percent Wt. Retained 100% |  |
| T556L0TM1 Tactical® 5.56x45mm-43 Gr. Lite Open Tip Match |  | Velocity 3212 Penetration 4.5" Expansion Fragment Retained Wt. NA Percent Wt. Retained NA |  |
| T556L0TM2 Tactical® 5.56x45mm-50 Gr. Lite Open Tip Match |  | Velocity 3219 Penetration 9.75" Expansion Fragment Retained Wt. 19 Gr. Percent Wt. Retained 38.00% |  |
| T223M Tactical® TRU® 223-69 Gr. Sierra® MatchKing® BTHP |  | Velocity 2613 Penetration 6" Expansion .312" Retained Wt. 13.7 Gr. Percent Wt. Retained 19.86% |  |
| T223M3 Tactical® TRU® 223-77 Gr. Sierra® MatchKing® BTHP |  | Velocity 2437 Penetration 7" Expansion Fragment Retained Wt. 10.3 Gr. Percent Wt. Retained 13.38% |  |

Expansion, retained weight and percentage retained weight are based on the largest available bullet fragment. Velocity are based on 5 round averages from the test rifle.



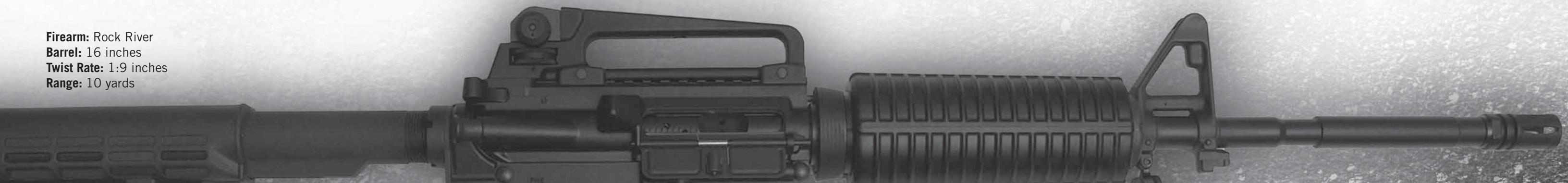











Firearm: Rock River
Barrel: 16 inches
Twist Rate: 1:9 inches
Range: 10 yards

















.223

WALL BOARD

STEEL

| Caliber | Wound Characteristics | Stats | Recovered Bullet |
|--|---|--|---|
| T223S Tactical® TRU® 223-55 Gr. Barnes® Triple-Shock® X-Bullet™ |  | Velocity 2764 Penetration 23.75" Expansion .223" Retained Wt. 55.2 Gr. Percent Wt. Retained 100% |  |
| 24455 Gold Dot® 5.56x45mm-55 Gr. Bonded Soft Point |  | Velocity 3013 Penetration 11.25" Expansion .441" Retained Wt. 25.2 Gr. Percent Wt. Retained 45.82% |  |
| 24448 Gold Dot® 223-64 Gr. Bonded Soft Point |  | Velocity 2692 Penetration 11.5" Expansion .325" Retained Wt. 31.3 Gr. Percent Wt. Retained 48.91% |  |
| T556L0TM1 Tactical® 5.56x45mm-43 Gr. Lite Open Tip Match |  | Velocity 3212 Penetration 8" Expansion Fragment Retained Wt. NA Percent Wt. Retained NA |  |
| T556L0TM2 Tactical® 5.56x45mm-50 Gr. Lite Open Tip Match |  | Velocity 3219 Penetration 8.75" Expansion Fragment Retained Wt. NA Percent Wt. Retained NA |  |
| T223M Tactical® TRU® 223-69 Gr. Sierra® MatchKing® BTHP |  | Velocity 2613 Penetration 5.25" Expansion Fragment Retained Wt. NA Percent Wt. Retained NA |  |
| T223M3 Tactical® TRU® 223-77 Gr. Sierra® MatchKing® BTHP |  | Velocity 2437 Penetration 6" Expansion Fragment Retained Wt. NA Percent Wt. Retained NA |  |

| Caliber | Wound Characteristics | Stats | Recovered Bullet |
|--|---|--|---|
| T223S Tactical® TRU® 223-55 Gr. Barnes® Triple-Shock® X-Bullet™ |  | Velocity 2764 Penetration 17.25" Expansion .534" Retained Wt. 55 Gr. Percent Wt. Retained 100% |  |
| 24455 Gold Dot® 5.56x45mm-55 Gr. Bonded Soft Point |  | Velocity 3013 Penetration 14" Expansion .505" Retained Wt. 42.4 Gr. Percent Wt. Retained 77.09% |  |
| 24448 Gold Dot® 223-64 Gr. Bonded Soft Point |  | Velocity 2692 Penetration 19.5" Expansion .468 Retained Wt. 49 Gr. Percent Wt. Retained 76.56% |  |
| T556L0TM1 Tactical® 5.56x45mm-43 Gr. Lite Open Tip Match |  | Velocity 3212 Penetration 8" Expansion Fragment Retained Wt. NA Percent Wt. Retained NA |  |
| T556L0TM2 Tactical® 5.56x45mm-50 Gr. Lite Open Tip Match |  | Velocity 3219 Penetration 9" Expansion Fragment Retained Wt. NA Percent Wt. Retained NA |  |
| T223M Tactical® TRU® 223-69 Gr. Sierra® MatchKing® BTHP |  | Velocity 2613 Penetration 11.75" Expansion 44" Retained Wt. 19.7 Gr. Percent Wt. Retained 28.55% |  |
| T223M3 Tactical® TRU® 223-77 Gr. Sierra® MatchKing® BTHP |  | Velocity 2437 Penetration 14.5" Expansion Fragment Retained Wt. 17.9 Gr. Percent Wt. Retained 23.25% |  |

Expansion, retained weight and percentage retained weight are based on the largest available bullet fragment. Velocity are based on 5 round averages from the test rifle.

Firearm: Rock River
Barrel: 16 inches
Twist Rate: 1:9 inches
Range: 10 yards

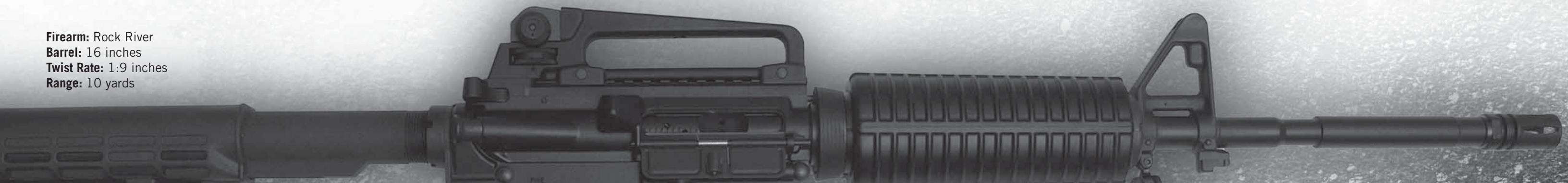

.223

GLASS

PLYWOOD

| Caliber | Wound Characteristics | Stats | Recovered Bullet | | | | | | | | | | |
|--|-----------------------|--|------------------|------|-------------|-------|-----------|----------|--------------|----------|----------------------|--------|--|
| T223S Tactical® TRU® 223-55 Gr. Barnes® Triple-Shock® X-Bullet™ | | <table border="1"> <tr><td>Velocity</td><td>2764</td></tr> <tr><td>Penetration</td><td>18"</td></tr> <tr><td>Expansion</td><td>.491"</td></tr> <tr><td>Retained Wt.</td><td>52.3 Gr.</td></tr> <tr><td>Percent Wt. Retained</td><td>95.09%</td></tr> </table> | Velocity | 2764 | Penetration | 18" | Expansion | .491" | Retained Wt. | 52.3 Gr. | Percent Wt. Retained | 95.09% | |
| Velocity | 2764 | | | | | | | | | | | | |
| Penetration | 18" | | | | | | | | | | | | |
| Expansion | .491" | | | | | | | | | | | | |
| Retained Wt. | 52.3 Gr. | | | | | | | | | | | | |
| Percent Wt. Retained | 95.09% | | | | | | | | | | | | |
| 24455 Gold Dot® 5.56x45mm-55 Gr. Bonded Soft Point | | <table border="1"> <tr><td>Velocity</td><td>3013</td></tr> <tr><td>Penetration</td><td>12.5"</td></tr> <tr><td>Expansion</td><td>.527"</td></tr> <tr><td>Retained Wt.</td><td>41.8 Gr.</td></tr> <tr><td>Percent Wt. Retained</td><td>76.00%</td></tr> </table> | Velocity | 3013 | Penetration | 12.5" | Expansion | .527" | Retained Wt. | 41.8 Gr. | Percent Wt. Retained | 76.00% | |
| Velocity | 3013 | | | | | | | | | | | | |
| Penetration | 12.5" | | | | | | | | | | | | |
| Expansion | .527" | | | | | | | | | | | | |
| Retained Wt. | 41.8 Gr. | | | | | | | | | | | | |
| Percent Wt. Retained | 76.00% | | | | | | | | | | | | |
| 24448 Gold Dot® 223-64 Gr. Bonded Soft Point | | <table border="1"> <tr><td>Velocity</td><td>2692</td></tr> <tr><td>Penetration</td><td>14.5"</td></tr> <tr><td>Expansion</td><td>.481"</td></tr> <tr><td>Retained Wt.</td><td>39.9 Gr.</td></tr> <tr><td>Percent Wt. Retained</td><td>62.34%</td></tr> </table> | Velocity | 2692 | Penetration | 14.5" | Expansion | .481" | Retained Wt. | 39.9 Gr. | Percent Wt. Retained | 62.34% | |
| Velocity | 2692 | | | | | | | | | | | | |
| Penetration | 14.5" | | | | | | | | | | | | |
| Expansion | .481" | | | | | | | | | | | | |
| Retained Wt. | 39.9 Gr. | | | | | | | | | | | | |
| Percent Wt. Retained | 62.34% | | | | | | | | | | | | |
| T556L0TM1 Tactical® 5.56x45mm-43 Gr. Lite Open Tip Match | | <table border="1"> <tr><td>Velocity</td><td>3212</td></tr> <tr><td>Penetration</td><td>8.5"</td></tr> <tr><td>Expansion</td><td>Fragment</td></tr> <tr><td>Retained Wt.</td><td>NA</td></tr> <tr><td>Percent Wt. Retained</td><td>NA</td></tr> </table> | Velocity | 3212 | Penetration | 8.5" | Expansion | Fragment | Retained Wt. | NA | Percent Wt. Retained | NA | |
| Velocity | 3212 | | | | | | | | | | | | |
| Penetration | 8.5" | | | | | | | | | | | | |
| Expansion | Fragment | | | | | | | | | | | | |
| Retained Wt. | NA | | | | | | | | | | | | |
| Percent Wt. Retained | NA | | | | | | | | | | | | |
| T556L0TM2 Tactical® 5.56x45mm-50 Gr. Lite Open Tip Match | | <table border="1"> <tr><td>Velocity</td><td>3219</td></tr> <tr><td>Penetration</td><td>9.75"</td></tr> <tr><td>Expansion</td><td>Fragment</td></tr> <tr><td>Retained Wt.</td><td>NA</td></tr> <tr><td>Percent Wt. Retained</td><td>NA</td></tr> </table> | Velocity | 3219 | Penetration | 9.75" | Expansion | Fragment | Retained Wt. | NA | Percent Wt. Retained | NA | |
| Velocity | 3219 | | | | | | | | | | | | |
| Penetration | 9.75" | | | | | | | | | | | | |
| Expansion | Fragment | | | | | | | | | | | | |
| Retained Wt. | NA | | | | | | | | | | | | |
| Percent Wt. Retained | NA | | | | | | | | | | | | |
| T223M Tactical® TRU® 223-69 Gr. Sierra® MatchKing® BTHP | | <table border="1"> <tr><td>Velocity</td><td>2613</td></tr> <tr><td>Penetration</td><td>5"</td></tr> <tr><td>Expansion</td><td>Fragment</td></tr> <tr><td>Retained Wt.</td><td>NA</td></tr> <tr><td>Percent Wt. Retained</td><td>NA</td></tr> </table> | Velocity | 2613 | Penetration | 5" | Expansion | Fragment | Retained Wt. | NA | Percent Wt. Retained | NA | |
| Velocity | 2613 | | | | | | | | | | | | |
| Penetration | 5" | | | | | | | | | | | | |
| Expansion | Fragment | | | | | | | | | | | | |
| Retained Wt. | NA | | | | | | | | | | | | |
| Percent Wt. Retained | NA | | | | | | | | | | | | |
| T223M3 Tactical® TRU® 223-77 Gr. Sierra® MatchKing® BTHP | | <table border="1"> <tr><td>Velocity</td><td>2437</td></tr> <tr><td>Penetration</td><td>9.25"</td></tr> <tr><td>Expansion</td><td>Fragment</td></tr> <tr><td>Retained Wt.</td><td>30.6 Gr.</td></tr> <tr><td>Percent Wt. Retained</td><td>39.74%</td></tr> </table> | Velocity | 2437 | Penetration | 9.25" | Expansion | Fragment | Retained Wt. | 30.6 Gr. | Percent Wt. Retained | 39.74% | |
| Velocity | 2437 | | | | | | | | | | | | |
| Penetration | 9.25" | | | | | | | | | | | | |
| Expansion | Fragment | | | | | | | | | | | | |
| Retained Wt. | 30.6 Gr. | | | | | | | | | | | | |
| Percent Wt. Retained | 39.74% | | | | | | | | | | | | |

| Caliber | Wound Characteristics | Stats | Recovered Bullet | | | | | | | | | | |
|--|-----------------------|--|------------------|------|-------------|--------|-----------|----------|--------------|----------|----------------------|--------|--|
| T223S Tactical® TRU® 223-55 Gr. Barnes® Triple-Shock® X-Bullet™ | | <table border="1"> <tr><td>Velocity</td><td>2764</td></tr> <tr><td>Penetration</td><td>15.75"</td></tr> <tr><td>Expansion</td><td>.485"</td></tr> <tr><td>Retained Wt.</td><td>46.9 Gr.</td></tr> <tr><td>Percent Wt. Retained</td><td>85.27%</td></tr> </table> | Velocity | 2764 | Penetration | 15.75" | Expansion | .485" | Retained Wt. | 46.9 Gr. | Percent Wt. Retained | 85.27% | |
| Velocity | 2764 | | | | | | | | | | | | |
| Penetration | 15.75" | | | | | | | | | | | | |
| Expansion | .485" | | | | | | | | | | | | |
| Retained Wt. | 46.9 Gr. | | | | | | | | | | | | |
| Percent Wt. Retained | 85.27% | | | | | | | | | | | | |
| 24455 Gold Dot® 5.56x45mm-55 Gr. Bonded Soft Point | | <table border="1"> <tr><td>Velocity</td><td>3013</td></tr> <tr><td>Penetration</td><td>7.5"</td></tr> <tr><td>Expansion</td><td>.344"</td></tr> <tr><td>Retained Wt.</td><td>15.2 Gr.</td></tr> <tr><td>Percent Wt. Retained</td><td>27.64%</td></tr> </table> | Velocity | 3013 | Penetration | 7.5" | Expansion | .344" | Retained Wt. | 15.2 Gr. | Percent Wt. Retained | 27.64% | |
| Velocity | 3013 | | | | | | | | | | | | |
| Penetration | 7.5" | | | | | | | | | | | | |
| Expansion | .344" | | | | | | | | | | | | |
| Retained Wt. | 15.2 Gr. | | | | | | | | | | | | |
| Percent Wt. Retained | 27.64% | | | | | | | | | | | | |
| 24448 Gold Dot® 223-64 Gr. Bonded Soft Point | | <table border="1"> <tr><td>Velocity</td><td>2692</td></tr> <tr><td>Penetration</td><td>14"</td></tr> <tr><td>Expansion</td><td>Fragment</td></tr> <tr><td>Retained Wt.</td><td>8.7 Gr.</td></tr> <tr><td>Percent Wt. Retained</td><td>13.59%</td></tr> </table> | Velocity | 2692 | Penetration | 14" | Expansion | Fragment | Retained Wt. | 8.7 Gr. | Percent Wt. Retained | 13.59% | |
| Velocity | 2692 | | | | | | | | | | | | |
| Penetration | 14" | | | | | | | | | | | | |
| Expansion | Fragment | | | | | | | | | | | | |
| Retained Wt. | 8.7 Gr. | | | | | | | | | | | | |
| Percent Wt. Retained | 13.59% | | | | | | | | | | | | |
| T556L0TM1 Tactical® 5.56x45mm-43 Gr. Lite Open Tip Match | | <table border="1"> <tr><td>Velocity</td><td>3212</td></tr> <tr><td>Penetration</td><td>3.5"</td></tr> <tr><td>Expansion</td><td>Fragment</td></tr> <tr><td>Retained Wt.</td><td>NA</td></tr> <tr><td>Percent Wt. Retained</td><td>NA</td></tr> </table> | Velocity | 3212 | Penetration | 3.5" | Expansion | Fragment | Retained Wt. | NA | Percent Wt. Retained | NA | |
| Velocity | 3212 | | | | | | | | | | | | |
| Penetration | 3.5" | | | | | | | | | | | | |
| Expansion | Fragment | | | | | | | | | | | | |
| Retained Wt. | NA | | | | | | | | | | | | |
| Percent Wt. Retained | NA | | | | | | | | | | | | |
| T556L0TM2 Tactical® 5.56x45mm-50 Gr. Lite Open Tip Match | | <table border="1"> <tr><td>Velocity</td><td>3219</td></tr> <tr><td>Penetration</td><td>5"</td></tr> <tr><td>Expansion</td><td>Fragment</td></tr> <tr><td>Retained Wt.</td><td>NA</td></tr> <tr><td>Percent Wt. Retained</td><td>NA</td></tr> </table> | Velocity | 3219 | Penetration | 5" | Expansion | Fragment | Retained Wt. | NA | Percent Wt. Retained | NA | |
| Velocity | 3219 | | | | | | | | | | | | |
| Penetration | 5" | | | | | | | | | | | | |
| Expansion | Fragment | | | | | | | | | | | | |
| Retained Wt. | NA | | | | | | | | | | | | |
| Percent Wt. Retained | NA | | | | | | | | | | | | |
| T223M Tactical® TRU® 223-69 Gr. Sierra® MatchKing® BTHP | | <table border="1"> <tr><td>Velocity</td><td>2613</td></tr> <tr><td>Penetration</td><td>12"</td></tr> <tr><td>Expansion</td><td>.226"</td></tr> <tr><td>Retained Wt.</td><td>14.1 Gr.</td></tr> <tr><td>Percent Wt. Retained</td><td>20.43%</td></tr> </table> | Velocity | 2613 | Penetration | 12" | Expansion | .226" | Retained Wt. | 14.1 Gr. | Percent Wt. Retained | 20.43% | |
| Velocity | 2613 | | | | | | | | | | | | |
| Penetration | 12" | | | | | | | | | | | | |
| Expansion | .226" | | | | | | | | | | | | |
| Retained Wt. | 14.1 Gr. | | | | | | | | | | | | |
| Percent Wt. Retained | 20.43% | | | | | | | | | | | | |
| T223M3 Tactical® TRU® 223-77 Gr. Sierra® MatchKing® BTHP | | <table border="1"> <tr><td>Velocity</td><td>2437</td></tr> <tr><td>Penetration</td><td>7"</td></tr> <tr><td>Expansion</td><td>Fragment</td></tr> <tr><td>Retained Wt.</td><td>NA</td></tr> <tr><td>Percent Wt. Retained</td><td>NA</td></tr> </table> | Velocity | 2437 | Penetration | 7" | Expansion | Fragment | Retained Wt. | NA | Percent Wt. Retained | NA | |
| Velocity | 2437 | | | | | | | | | | | | |
| Penetration | 7" | | | | | | | | | | | | |
| Expansion | Fragment | | | | | | | | | | | | |
| Retained Wt. | NA | | | | | | | | | | | | |
| Percent Wt. Retained | NA | | | | | | | | | | | | |

Expansion, retained weight and percentage retained weight are based on the largest available bullet fragment. Velocity are based on 5 round averages from the test rifle.



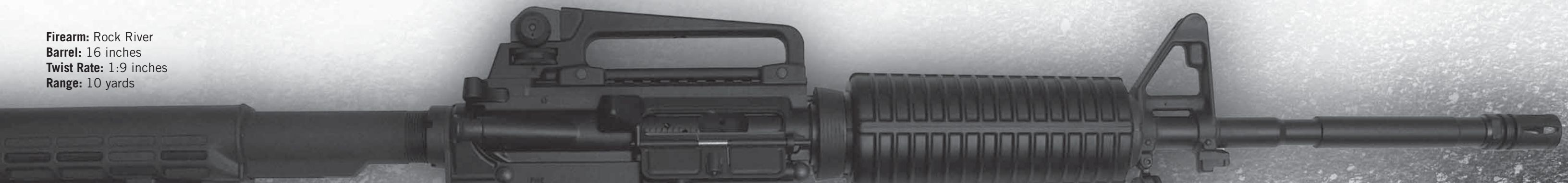











Firearm: Rock River
Barrel: 16 inches
Twist Rate: 1:9 inches
Range: 10 yards

















.308

HEAVY CLOTHING

BARE GELATIN

| Caliber | Wound Characteristics | Stats | Recovered Bullet |
|--|---|--|---|
| GM308M Gold Medal® 308-168 Gr. Sierra® MatchKing® BTHP  |  | Velocity 2459 Penetration 20" Expansion .617" Retained Wt. 84.4 Gr. Percent Wt. Retained 50.24% |  |
| GM308M2 Gold Medal® 308-175 Gr. Sierra® MatchKing® BTHP  |  | Velocity 2493 Penetration 23.5 Expansion .620 Retained Wt. 86.4 Gr. Percent Wt. Retained 49.37% |  |
| T308M Tactical® TRU® 308-165 Gr. Sierra® BTHP  |  | Velocity 2604 Penetration 15.5" Expansion Fragment Retained Wt. 48.8 Gr. Percent Wt. Retained 29.58% |  |
| 24457 Gold Dot® 308-150 Gr. Bonded Soft Point  |  | Velocity 2678 Penetration 17.75" Expansion .85 Retained Wt. 155 Gr. Percent Wt. Retained 100% |  |
| 24458 Gold Dot® 308-168 Gr. Bonded Soft Point  |  | Velocity 2542 Penetration 19.62" Expansion .762" Retained Wt. 156.4 Gr. Percent Wt. Retained 93.10% |  |

| Caliber | Wound Characteristics | Stats | Recovered Bullet |
|---|---|--|---|
| GM308M Gold Medal® 308-168 Gr. Sierra® MatchKing® BTHP  |  | Velocity 2459 Penetration 20.5" Expansion .670" Retained Wt. 109.4 Gr. Percent Wt. Retained 65.12% |  |
| GM308M2 Gold Medal® 308-175 Gr. Sierra® MatchKing® BTHP  |  | Velocity 2493 Penetration 14.75" Expansion Fragment Retained Wt. 127 Gr. Percent Wt. Retained 72.57% |  |
| T308M Tactical® TRU® 308-165 Gr. Sierra® BTHP  |  | Velocity 2604 Penetration 20.25" Expansion .578" Retained Wt. 73.6 Gr. Percent Wt. Retained 44.61% |  |
| 24457 Gold Dot® 308-150 Gr. Bonded Soft Point  |  | Velocity 2678 Penetration 18" Expansion .7565" Retained Wt. 150 Gr. Percent Wt. Retained 100% |  |
| 24458 Gold Dot® 308-168 Gr. Bonded Soft Point  |  | Velocity 2542 Penetration 22.5" Expansion .497" Retained Wt. 150.3 Gr. Percent Wt. Retained 89.46% |  |

Expansion, retained weight and percentage retained weight are based on the largest available bullet fragment. Velocity are based on 5 round averages from the test rifle.



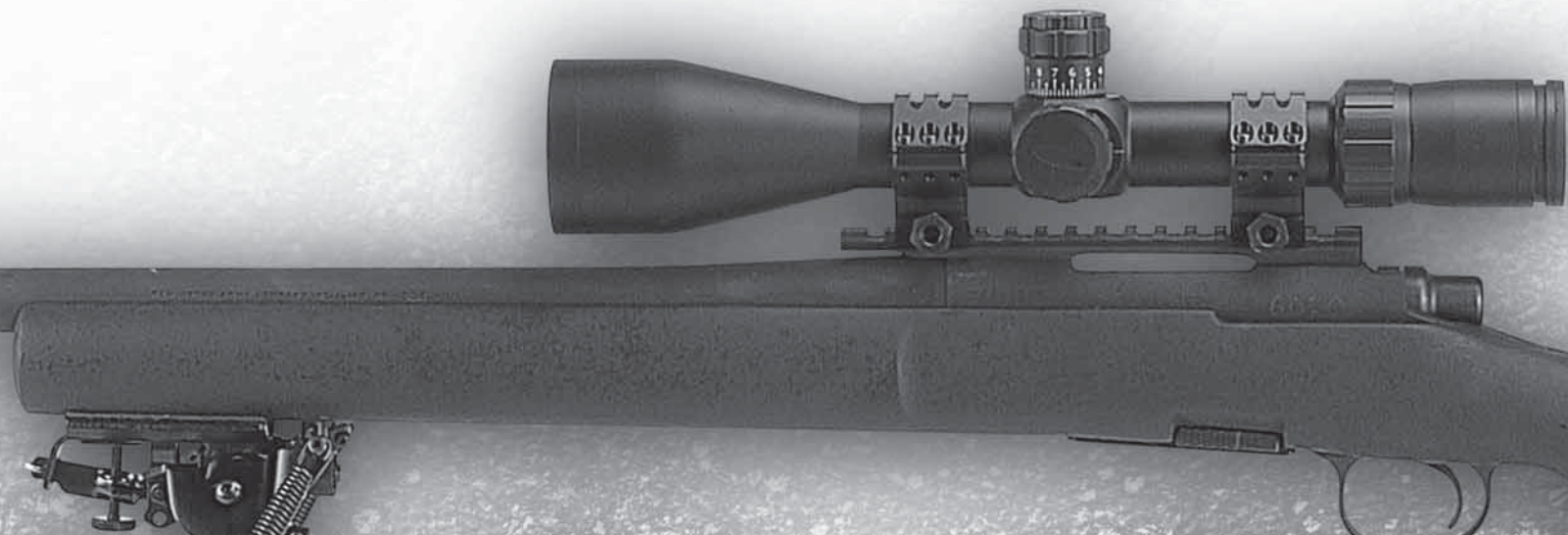











Firearm: Remington 700P
Barrel: 20 inches
Twist Rate: 1:12 inches
Range: 50 yards

















.308

WALL BOARD

STEEL

| Caliber | Wound Characteristics | Stats | Recovered Bullet |
|--|---|---|---|
| GM308M Gold Medal® 308-168 Gr. Sierra® MatchKing® BTHP  |  | Velocity 2459 Penetration 17" Expansion .504" Retained Wt. 168.5 Gr. Percent Wt. Retained 100% |  |
| GM308M2 Gold Medal® 308-175 Gr. Sierra® MatchKing® BTHP  |  | Velocity 2493 Penetration 16.25" Expansion .418" Retained Wt. 31.1 Gr. Percent Wt. Retained 17.77% |  |
| T308M Tactical® TRU® 308-165 Gr. Sierra® BTHP  |  | Velocity 2604 Penetration 21.25" Expansion .737" Retained Wt. 154.9 Gr. Percent Wt. Retained 93.88% |  |
| 24457 Gold Dot® 308-150 Gr. Bonded Soft Point  |  | Velocity 2678 Penetration 19.25" Expansion .922" Retained Wt. 141.3 Gr. Percent Wt. Retained 94.20% |  |
| 24458 Gold Dot® 308-168 Gr. Bonded Soft Point  |  | Velocity 2542 Penetration 21.25" Expansion .478" Retained Wt. 130.8 Gr. Percent Wt. Retained 77.86% |  |

| Caliber | Wound Characteristics | Stats | Recovered Bullet |
|---|---|--|---|
| GM308M Gold Medal® 308-168 Gr. Sierra® MatchKing® BTHP  |  | Velocity 2459 Penetration 20.5" Expansion Fragment Retained Wt. 2.5 Gr. Percent Wt. Retained 1.49% |  |
| GM308M2 Gold Medal® 308-175 Gr. Sierra® MatchKing® BTHP  |  | Velocity 2493 Penetration 18.5" Expansion Fragment Retained Wt. 98.1 Gr. Percent Wt. Retained 56.06% |  |
| T308M Tactical® TRU® 308-165 Gr. Sierra® BTHP  |  | Velocity 2604 Penetration 15.25" Expansion .740" Retained Wt. 137.1 Gr. Percent Wt. Retained 83.09% |  |
| 24457 Gold Dot® 308-150 Gr. Bonded Soft Point  |  | Velocity 2678 Penetration 19" Expansion .7945" Retained Wt. 150 Gr. Percent Wt. Retained 100% |  |
| 24458 Gold Dot® 308-168 Gr. Bonded Soft Point  |  | Velocity 2452 Penetration 24" Expansion .370" Retained Wt. 112.2 Gr. Percent Wt. Retained 66.79% |  |

Expansion, retained weight and percentage retained weight are based on the largest available bullet fragment. Velocity are based on 5 round averages from the test rifle.



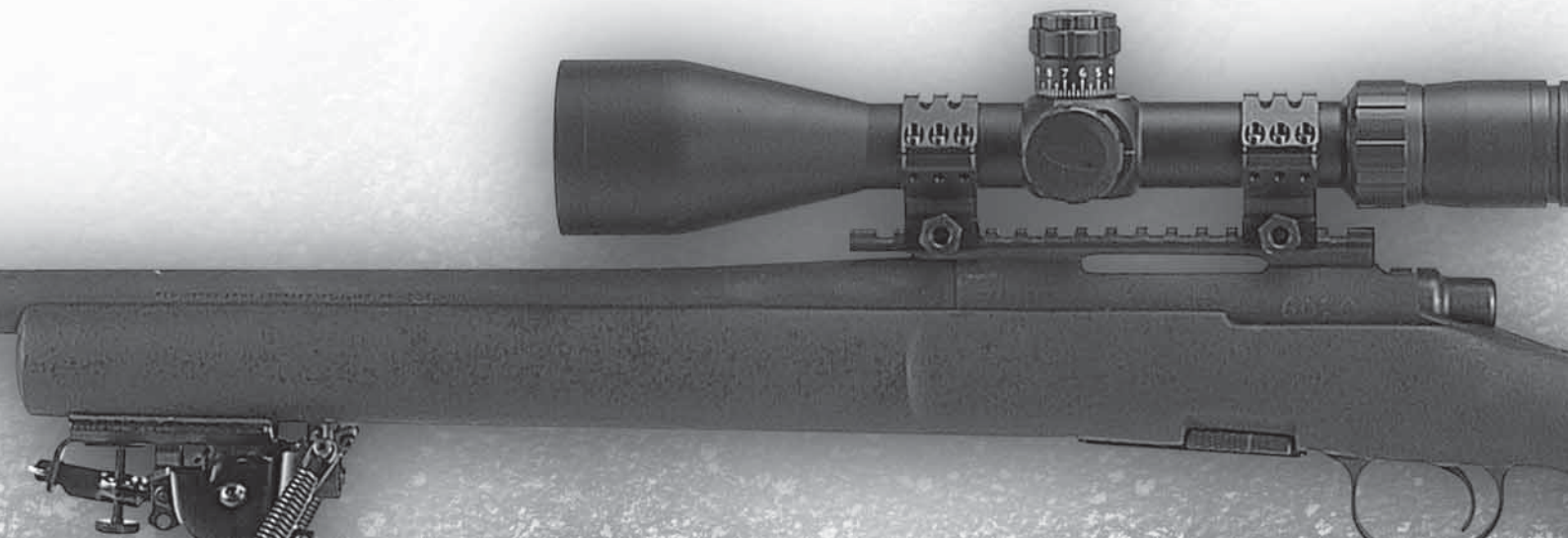











Firearm: Remington 700P
Barrel: 20 inches
Twist Rate: 1:12 inches
Range: 50 yards

















.308

GLASS

PLYWOOD

| Caliber | Wound Characteristics | Stats | Recovered Bullet |
|--|---|--|---|
| GM308M Gold Medal® 308-168 Gr. Sierra® MatchKing® BTHP  |  | Velocity 2459 Penetration 15.75" Expansion .965" Retained Wt. 96.8 Gr. Percent Wt. Retained 57.62% |  |
| GM308M2 Gold Medal® 308-175 Gr. Sierra® MatchKing® BTHP  |  | Velocity 2493 Penetration 15.25" Expansion .629" Retained Wt. 143.6 Gr. Percent Wt. Retained 82.06% |  |
| T308M Tactical® TRU® 308-165 Gr. Sierra® BTHP  |  | Velocity 2604 Penetration 15.625" Expansion .654" Retained Wt. 81.9 Gr. Percent Wt. Retained 49.64% |  |
| 24457 Gold Dot® 308-150 Gr. Bonded Soft Point  |  | Velocity 2678 Penetration 18.5" Expansion .824" Retained Wt. 139.1 Gr. Percent Wt. Retained 92.73% |  |
| 24458 Gold Dot® 308-168 Gr. Bonded Soft Point  |  | Velocity 2542 Penetration 21.125" Expansion .916" Retained Wt. 153.4 Gr. Percent Wt. Retained 91.31% |  |

| Caliber | Wound Characteristics | Stats | Recovered Bullet |
|---|---|--|---|
| GM308M Gold Medal® 308-168 Gr. Sierra® MatchKing® BTHP  |  | Velocity 2459 Penetration 11.875" Expansion .599" Retained Wt. 83.9 Gr. Percent Wt. Retained 49.94% |  |
| GM308M2 Gold Medal® 308-175 Gr. Sierra® MatchKing® BTHP  |  | Velocity 2493 Penetration 12.625" Expansion .391" Retained Wt. 22.3 Gr. Percent Wt. Retained 12.74% |  |
| T308M Tactical® TRU® 308-165 Gr. Sierra® BTHP  |  | Velocity 2604 Penetration 9.625" Expansion .688" Retained Wt. 71.1 Gr. Percent Wt. Retained 43.09% |  |
| 24457 Gold Dot® 308-150 Gr. Bonded Soft Point  |  | Velocity 2678 Penetration 12.25" Expansion .562" Retained Wt. 44.6 Gr. Percent Wt. Retained 29.73% |  |
| 24458 Gold Dot® 308-168 Gr. Bonded Soft Point  |  | Velocity 2542 Penetration 13.875" Expansion .887" Retained Wt. 116.9 Gr. Percent Wt. Retained 69.58% |  |

Expansion, retained weight and percentage retained weight are based on the largest available bullet fragment.
 Velocity are based on 5 round averages from the test rifle.

Firearm: Remington 700P
Barrel: 20 inches
Twist Rate: 1:12 inches
Range: 50 yards

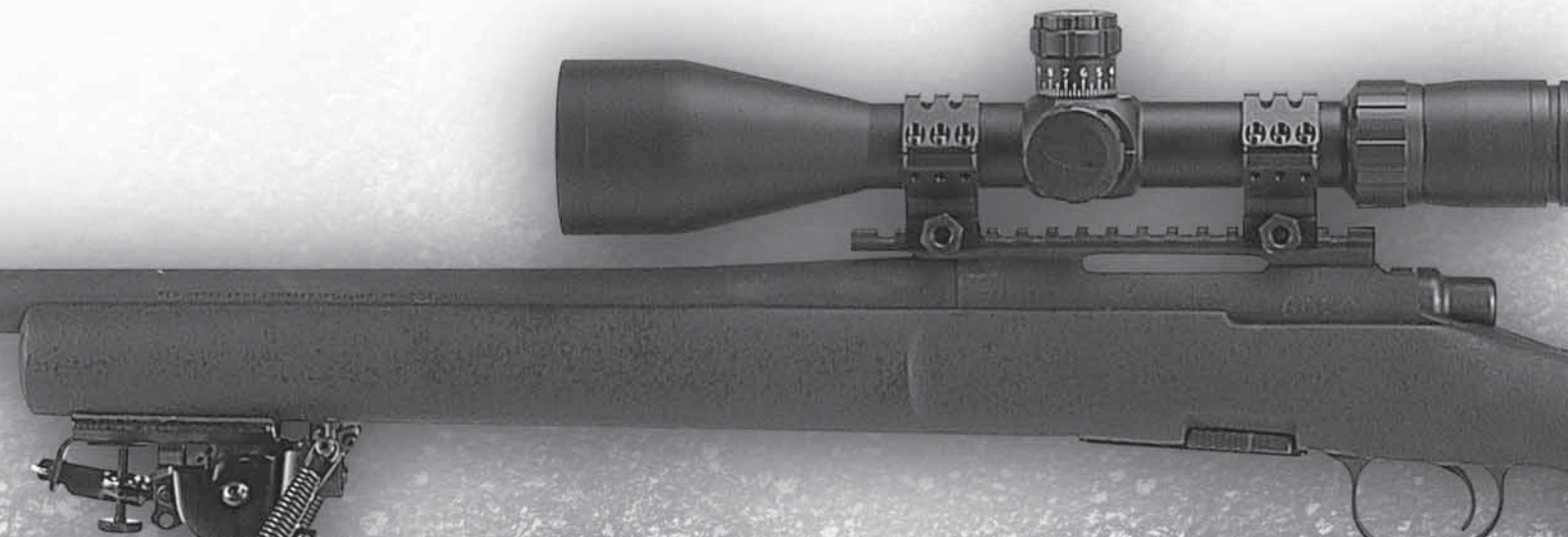

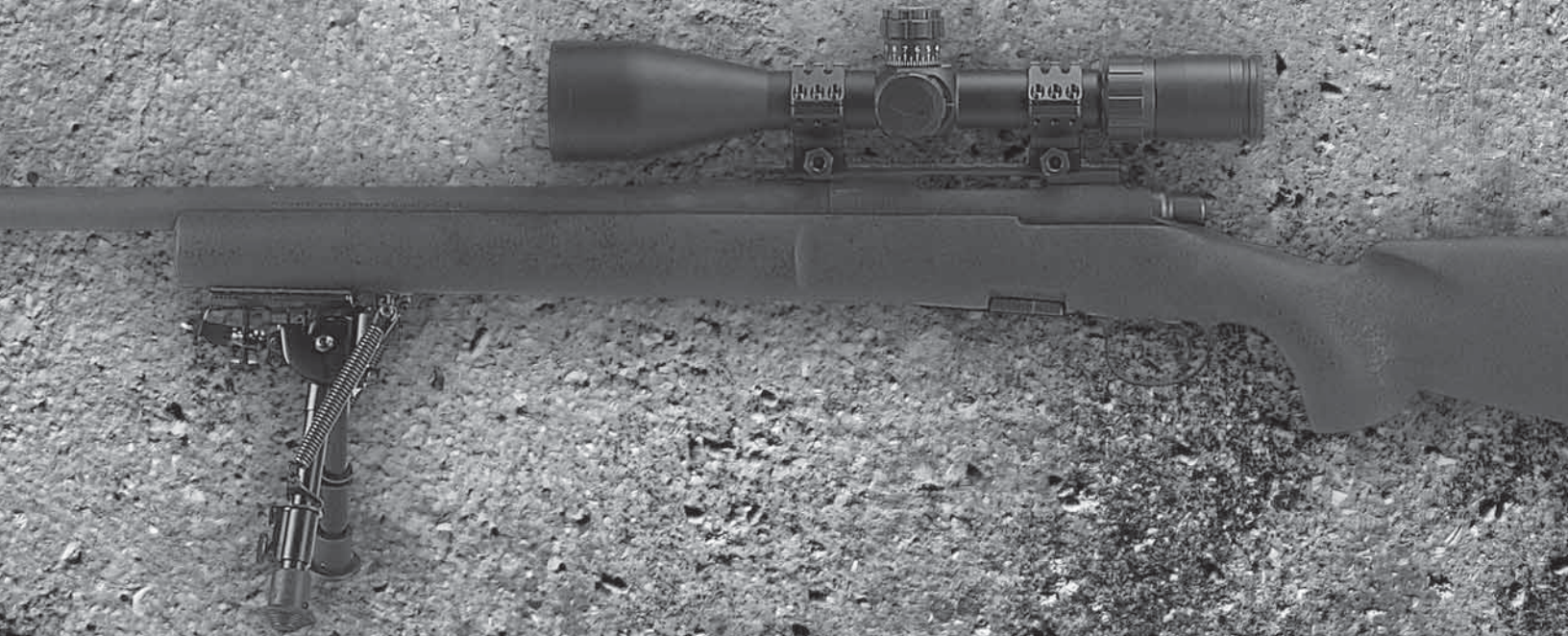

**FEDERAL
PREMIUM[®]**
LAW ENFORCEMENT
AMMUNITION

ATK

www.le.atk.com

speer **LE**